

**PLEASE READ AND FOLLOW ALL SAFETY INSTRUCTIONS****SAVE THIS SHEET****To Avoid Risk of Electric Shock and Injury**

- Never attempt any work on the luminaire unless it is disconnected from the power source.
- Any installation and service of the luminaire should be done by a certified electrician.
- Confirm the supply voltage matches the voltage labeled on the luminaire.
- Make sure all electrical and grounded connections are in accordance with the National Electric Code (NEC) and any local codes.
- Make sure all connections are capped with UL-listed wire connectors.
- Allow luminaire to cool down before handling. Never handle luminaire when it is in use.
- Do not exceed the maximum wattage labeled on luminaire.
- Always wear gloves and safety glasses when installing, handling, or performing routine maintenance on the luminaire.
- Do not look directly at the light source when luminaire is on.

**To Avoid Risk of Fire and Product Damage**

- Keep any combustible material away from the luminaire.
- Do not operate luminaire near any persons, materials, or substances that are sensitive to heat.
- When mounting, make sure wiring is secured from any edges or objects that can damage the wire insulation.
- Do not obstruct ventilation of the luminaire. Do not cover the luminaire with foam or other insulation material that will restrict convection or conduction cooling.
- Only use luminaire at its intended location.
- LED fixtures are sensitive to polarity. Make sure to identify proper polarity before installing.
- Electrostatic Discharge (or ESD) can damage LED luminaire. Make sure to always wear personal grounding equipment when installing or servicing the luminaire.
- Avoid touching individual electrical components, which can cause ESD and will reduce the life and performance of the luminaire.
- Do not power luminaire on and off frequently as this will greatly reduce luminaire's lifespan.
- Always read the luminaire's complete installation instruction sheet before installing luminaire.
- Always inspect the luminaire for damage. DO NOT INSTALL fixture if there is any damage. Contact your distributor or representative where you purchased the luminaire for warranty claim if luminaire is damaged.

**To Maintain Luminaire and Ensure Consistent Performance**

- **IMPORTANT: Always make sure luminaire is disconnected from power source when performing routine maintenance.**
- Occasionally clean luminaire lens. When cleaning lens, you may dust with soft, dry and clean cloth. You may also use solution of warm water and non-abrasive cleaning agent then wipe with dry cloth. DO NOT USE alkaline or acid cleaners.
- Keep heatsink clear of dust or debris from time to time.
- Maintaining the luminaire on a routine basis is highly recommended.

Failure to follow any of these instructions may void warranty.

Please visit [www.alslighting.us](http://www.alslighting.us) to view complete product Terms and Conditions.

Advantage Lighting Solutions assumes no responsibility for claims arising from improper or careless installation or handling of its products.

**Important Safety Instructions**

1. Make sure power is turned OFF before installing.
2. Inspect fixture for any damages. If damaged, DO NOT install fixture and contact local ALS distributor immediately.

Drilling Template

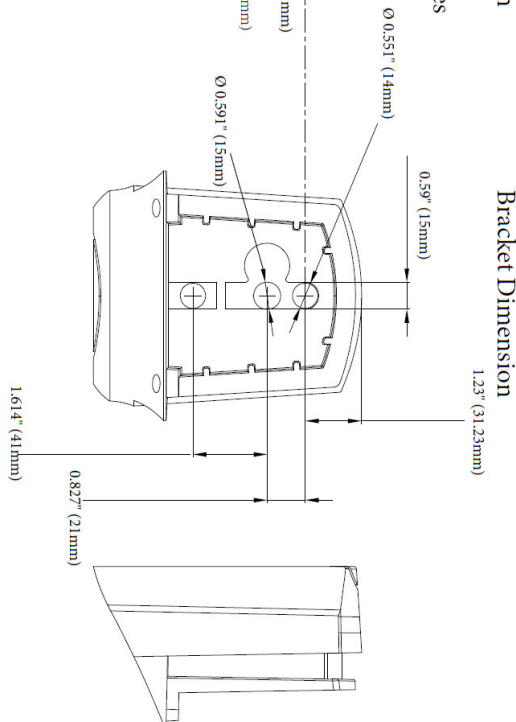
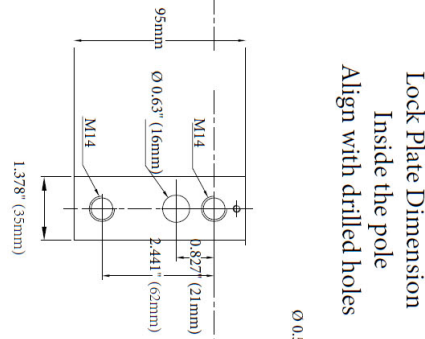
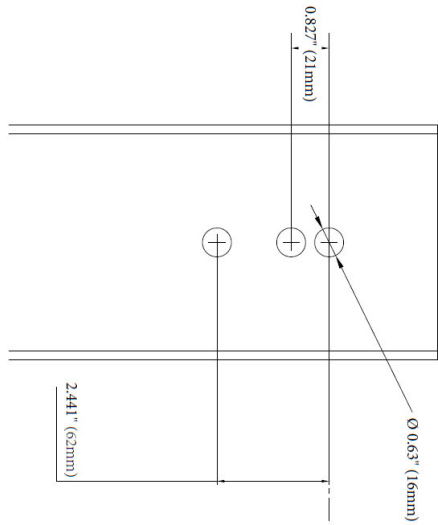

**Installation Instructions**

**Square Pole**

1. Pre-drill pole according to drilling template.
2. Insert mounting plate and fasten bolt halfway on top hole. (Fig. 1)
3. Slide SR bracket onto bolt, fasten bolt to secure, insert and fasten additional bolt through bottom hole. (Fig. 2)
4. Feed power cord through center hole into pole for electrical connection, slide fixture onto SR bracket. Insert 2 screws from bottom up to secure fixture on bracket. (Fig. 3)
5. Make wiring connection as per wire diagram inside pole to complete installation.

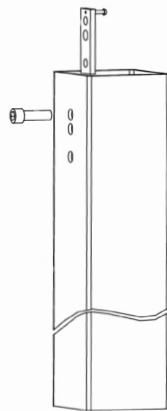

Fig 1

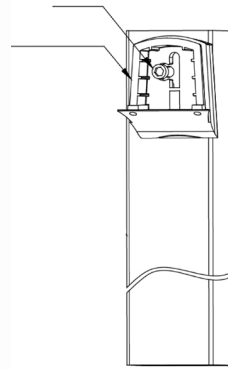

Fig 2

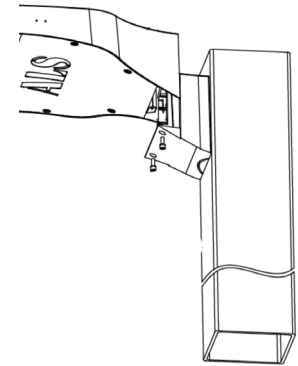

Fig 3

**Installation Instructions**

**Round Pole**

1. Use hammer gently knock down top and bottom lips. (Fig. 4)
2. Follow Square Pole Installation

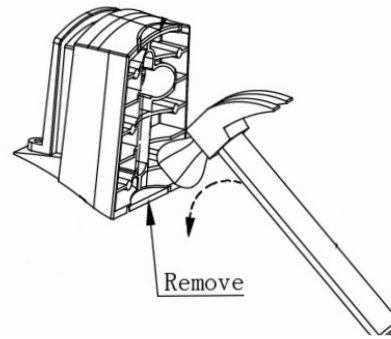

Fig 4

**Installation Instructions**

**Wall Mount**

1. Feed fixture electrical cord through SF bracket and make wiring connection as per wire diagram inside pole.
2. Slide fixture onto SF bracket, insert 2 screws from bottom up to secure fixture on bracket.
3. Fasten all set screws on SF bracket onto pole / tenon.

