



## AL6A SERIES AREA LIGHT

Client:  
Project:  
Type:  
Quantity:

### CONSTRUCTION

Die-cast aluminum housing with hinged, die-cast aluminum door.  
Low profile, 3G vibration rated compact design minimizes wind load requirements.  
Downward opening electrical hinged door completely sealed against moisture and dust.  
CCT / Output Dipswitch accessible through knockout opening on driver enclosure.

### OPTICS

UV-resistant polycarbonate optics, available in Type III distributions.  
Optics is precisely designed to shape the distribution, maximizing efficiency and application spacing.

### ELECTRICAL

80+ CRI Lumileds LED.  
-40°C up to 50°C (-40°F up to 122°F) maximum operating temperature.  
Long-life 120,000 hr LED at L70 @ 25°C.  
Driver operates at 120-277V input, 0-10V dimmable driver, down to 10%.  
50/60Hz, <11% THD, 0.9 power factor.  
Integral CCT / Output Selectable Dipswitch.  
Optional 10kV surge protection.

### SENSORS (OPTIONAL)

SENSOR-BLE-6-4T Integral PIR ALS Control bluetooth/on/off/dimming/photosensing.  
SENSOR-ANT-6-4T Plug-N-Play PIR on/off/dimming/photosensing.  
SENSOR-PH-PB-U Integral button style photocell.  
SENSOR-PH-PT-U/UD Twist lock dimming/non-dimming photocontrol.

### MOUNTING

Adjustable slipfitter mount bracket for 2-3/8" tenon as standard.  
Optional adjustable round (RL) or square (SL) pole mount.  
Optional adjustable wall mount (WM) bracket.

### STANDARD FINISH

Corrosion resistant Dark Bronze powder coating finish.

### CERTIFICATION

IP65 Wet location label standard.  
Meets Buy America Act requirements.  
IDA compliant: with 3000K color temperature selection.  
Title 24 compliant; see local ordinance for qualification information.  
All luminaires are built to UL1598 standards and bear appropriate cETLus labels.  
Electrical Driver and luminaire compliant with CE standard.  
DLC® Premium (DesignLights Consortium Qualified) listed.

### WARRANTY

5 year warranty, see Limited Warranty for additional information.



300W w/Slipfitter Mount

### SHIPPING DATA

Product	Measurement	Weight
AL6A-150SC	23"L x 16"W x 6"H	11 lb
AL6A-300SC	24"L x 17"W x 6"H	17 lb



**AL6A SERIES AREA LIGHT**

ORDER INFORMATION				EXAMPLE : AL6A 150 SC T3 DB UNVD		
Fixture	Series	Power & LM	CCT	Distribution	Finish	Input
	<b>AL6A</b>		<b>SC</b>	<b>T3</b>	<b>DB</b>	<b>UNVD</b>
Mounting			Accessories Options			

**A SERIES**

AL6A Dual Selectable Area Light

**B POWER & LM**

Code	Power (W)	LM
150	Field Selectable 100 / 120 / 150	13,000 ~ 19,500
300	Field Selectable 200 / 240 / 300	26,000 ~ 39,000

**C CCT**

SC Field Selectable 3000 ~ 5000K

**D DISTRIBUTION**

T3 Type III

**E FINISH**

Standard  
 DB Dark Bronze

**F INPUT**

UNVD 120-277V, 1-10V Dimmable

**G MOUNTING**

MOUNT-P-SF	Slipfitter (STANDARD)	MOUNT-P-SS	Square Pole-S
MOUNT-P-SL	Square Pole-L	MOUNT-P-RS	Round Pole-S
MOUNT-P-RL	Round Pole-L	MOUNT-P-WM	Wall Mount

**H ACCESSORIES/OPTIONS**

AIA	Assembled in America, compliant with BAA (COTS)
SENSOR-ANT-6-4T*	Integral PIR on/off/dimming/photosensing
SENSOR-BLE-6-4T*	"Plug-N-Play" Integral Bluetooth Daylight Harvesting Sensor (ALS Control Mobile App)
SENSOR-PH-PB-U*	Button Style Photocell
SENSOR-PH-PT-U / UD*	Twist Lock Photocell / <b>U:</b> 120-277V, <b>UD:</b> 120-277V
REMOTE-RC100	Handheld Remote Commissioning Tool for SENSOR-ANT (1 per job)
SURGE-LSP4-U	10kV inline Surge Protection for Universal input / <b>U:</b> 120-277V

\*see page 6 for sensor spec

**AL6A SERIES AREA LIGHT**

**DIMENSIONS**

Model	L	W	H
AL6A-150	10.31" (262mm)	12.71" (323mm)	2.66" (68mm)
AL6A-300	18.12" (460mm)	13.78" (350mm)	2.83" (72mm)

AL6A-150  
 Single-board layout

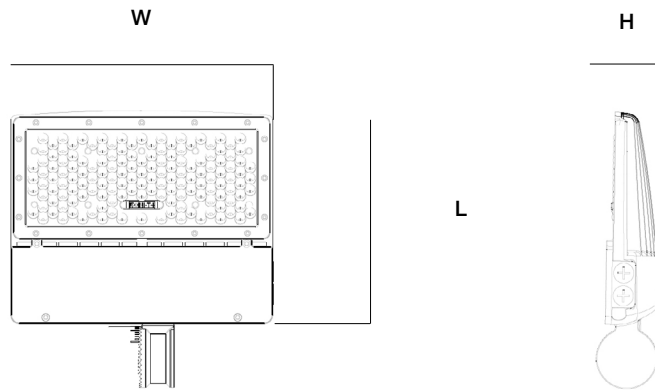

AL6A-300  
 Dual-board layout

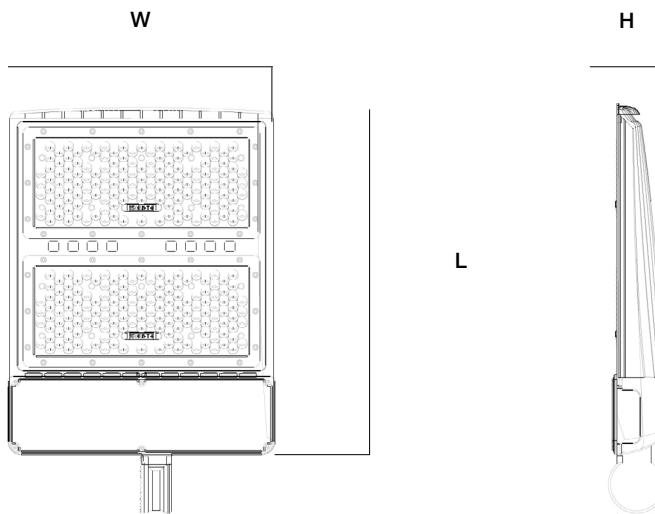

**AL6A SERIES AREA LIGHT**

**MOUNTING OPTIONS**

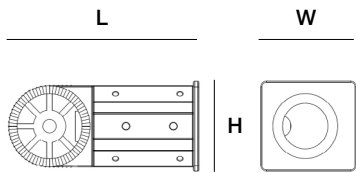

**SF** (Slipfitter)

L: 6.93" (176mm)  
 W: 3.46" (88mm)  
 H: 3.81" (97mm)

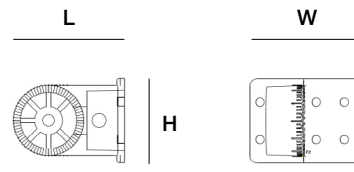

**WM** (Wall Mount)

L: 4.69" (119mm)  
 W: 4.82" (123mm)  
 H: 3.54" (90mm)

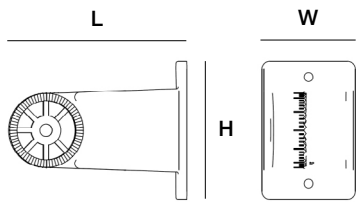

**SL** (Square Pole L)

L: 7.13" (181mm)  
 W: 3.74" (95mm)  
 H: 5.51" (140mm)

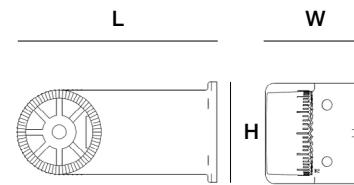

**SS** (Square Pole-S)

L: 7.05" (179mm)  
 W: 3.64" (93mm)  
 H: 3.54" (90mm)

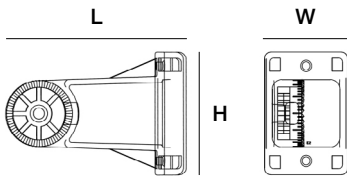

**RL** (Round Pole-L)

L: 8.09" (206mm)  
 W: 3.74" (95mm)  
 H: 5.51" (140mm)

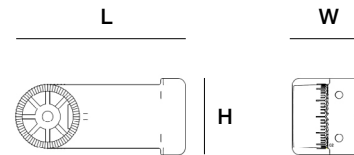

**RS** (Round Pole-S)

L: 7.88" (200mm)  
 W: 3.64" (93mm)  
 H: 3.54" (90mm)

**EPA (ft<sup>2</sup>)**

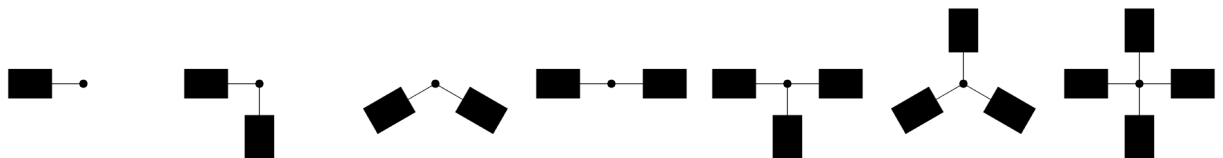

Mounting Option	Single	2 @ 90°	2 @ 120°	2 @ 180°	3 @ 90°	3 @ 120°	4 @ 90°
AL6A-150	0.282	0.490	0.732	0.626	0.866	0.963	0.866
AL6A-300	0.325	0.565	0.760	0.650	0.899	1.000	0.899

**AL6A SERIES AREA LIGHT**

**PERFORMANCE DATA**

SYSTEM WATTS	VOLTAGE	DIST.TYPE	3000K		4000K		5000K	
			LUMENS	LPW	LUMENS	LPW	LUMENS	LPW
100W	120-277V	III	12400	124	12700	127	13100	131
120W	120-277V	III	14880	124	15240	127	15720	131
150W	120-277V	III	19500	130	20100	134	20550	137
200W	120-277V	III	26200	131	27000	135	27600	138
240W	120-277V	III	31680	132	32640	136	33360	139
300W	120-277V	III	39900	133	41100	137	42000	140

**DLC CODE**

Part Number	DLC Part Number	DLC Class
AL6A - 150 SC T3 - DB UD 150W 3000K / 4000K / 5000K Selection	OEM Part# YR-PL322-W150D-Y1-[P,PM,M,N]-[A,B2,C2,D2,E2,FD,U](30/40/50K) Product ID: S-EWN1JU	Premium
AL6A - 300 SC T3 - DB UD 300W 3000K / 4000K / 5000K Selection	OEM Part# YR-PL322-W300D-Y1-[P,PM,M,N]-[A,B2,C2,D2,E2,FD,U](30/40/50K) Product ID: S-EWBTHA	Premium

**AL6A SERIES AREA LIGHT**

**SENSOR SPEC**

Model	Type	Mounting	Coverage	Input	Function	Programmable
SENSOR-ANT-6-4T	PIR	up to 40FT	30FT radius	12V DC	On/Off/Dimming	REMOTE-RC100
SENSOR-BLE-6-4T (see page7 for detail)	PIR	up to 40FT	30FT radius	12V DC	Bluetooth Mesh On/Off/Dimming Daylight Harvesting	ALS Control Bluetooth Mobile App
SENSOR-PH-PB-U	-	-	-	Universal	Dusk-to-Dawn Control	-
SENSOR-PH-PT-U SENSOR-PH-PT-UD	-	-	-	Universal	Dusk-to-Dawn Control	-



SENSOR-ANT-6-4T  
 SENSOR-BLE-6-4T



SENSOR-PH-PB-U



SENSOR-PH-PT-U/UD

**FEATURE**

- **Installation:** Plug-N-Play via AUX socket on attached fixture
- **Commissioning:** Wirelessly through ALS Control Mobile App (iOS / Android)
- **Certification:** DLC 5.1 Networked Lighting Control System
- **Control:** Hold time, High-Low setting, continuous Bi-level dimming, Code-compliant manual-on or auto-off capability
- **Sensor:** Motion (Occupancy/Vacancy/Manual) and Daylight Harvesting
- **Room and Zone Control:** Zoning and Grouping control, Scheduling



**SPECIFICATIONS**

<b>SENSOR TYPE:</b>	Passive Infrared Sensor (PIR)
<b>WIRELESS STANDARDS:</b>	5.0 Bluetooth Mesh
<b>INPUT VOLTAGE:</b>	12-24VDC, >50mA
<b>CONTROL OUTPUT:</b>	0-10V
<b>OPERATING TEMP:</b>	-4°F ~ +140°F (-20°C ~ +60°C)
<b>COMMISSIONING RANGE:</b>	50FT
<b>BLUETOOTH RANGE:</b>	164FT
<b>DETECTION ANGLE:</b>	360°
<b>MOUNTING HEIGHT:</b>	Up to 40FT
<b>WARRANTY:</b>	5 years
<b>IP RATING:</b>	IP65

**DIMENSIONS**

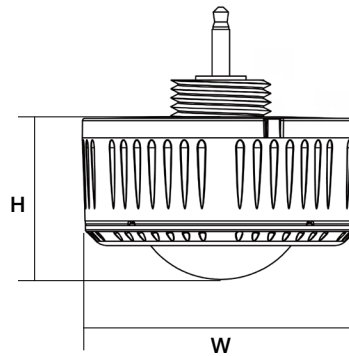

H	W
1.03" (26.2mm)	2.17" (55mm)

**COVERAGE PATTERNS**

